

IRIS[®]

EExd IIC IRIS UNISCAN APPLICATION MANUAL

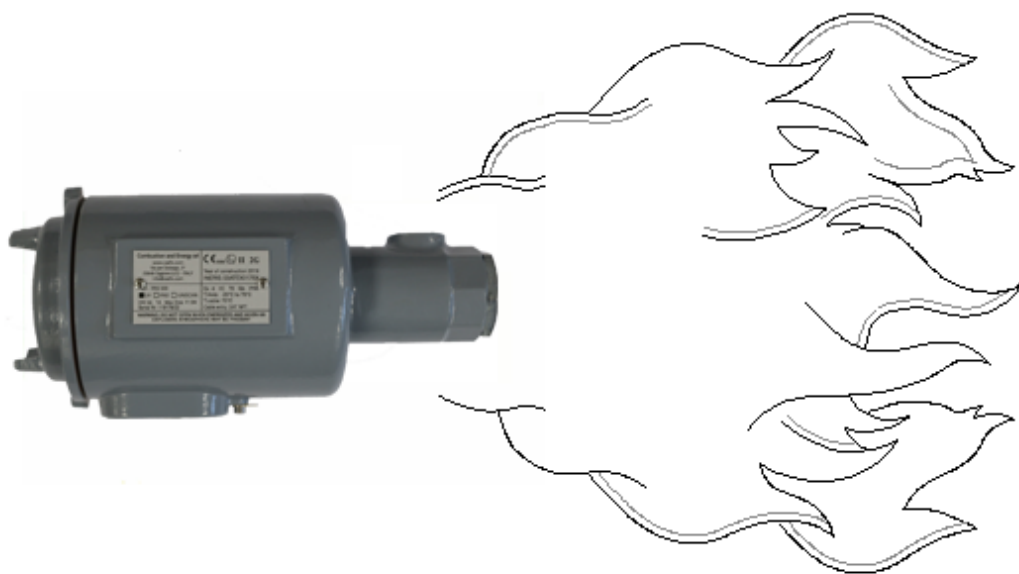

TABLE OF CONTENTS

DESCRIPTION	PAGE
IRIS - UNISCAN	2
SPECIFICATION.....	1
SUPPLY VOLTAGE: -	1
OUTPUTS: -	1
TRANSMISSION: -	1
CABLE: -	1
FLAME DROP OUT TIME: -	1
DISCRIMINATION CUT-OFF FREQUENCIES: -	1
ACCESSORIES: -	1
DESCRIPTION.....	1
IRIS UNISCAN EEXD - INSTALLATION & COMMISSIONING INSTRUCTIONS	1
INSTALLATION.....	1
WIRING	1
IMPORTANT	1
SETTINGS	1
SETTING UP PROCEDURE.....	2

LIST OF FIGURES

FIGURE 1	IRIS UNISCAN – PCB BOARD AND DETECTOR HEAD ASSEMBLY	2
FIGURE 2	IRIS UNISCAN – WIRING CONNECTOR	3
FIGURE 3	IRIS UNISCAN – UNISCAN POWER SUPPLY AND WIRING	3
FIGURE 4	IRIS UNISCAN – EEXd SCANNER HEAD	4
FIGURE 5	IRIS UNISCAN – UNISCAN HEAD SIGHTING	5



IRIS - UNISCAN

The Uniscan is a fail safe - self check flame monitor and amplifier mounted in one enclosure, suitable for gas or oil, pilot or main flame monitoring. The techniques used for discrimination and fail safety are unique and are covered by UK patent No. 2131585 and US patent No. 4540886.

SPECIFICATION

SUPPLY VOLTAGE:-

24V DC + 10% - 25% (separate module available - see accessories).

OUTPUTS:-

One normally open volt powered 20V DC contact for flame on (SPST). One 4-20mA output for flame strength indication.

TRANSMISSION:-

No limit providing supply cable is sized correctly.

CABLE:-

4 core 1.0mm² Controlflex SY with outer braid.

FLAME DROP OUT TIME:-

Selectable to 1, 2 or 3 seconds (factory set at 2 seconds)

DISCRIMINATION CUT-OFF FREQUENCIES:-

Selectable POS 1 = 36 Hz
 POS 2 = 71 Hz
 POS 3 = 105 Hz
 POS 4 = 186 Hz
 (factory set at POS 1)

SPECTRAL RESPONSE OF CELL:-

For Gas and Oil 750 - 1900nm B 1818

DIMENSIONS:- 283 x 120 diameter

WEIGHT:- 3.0 kgs

PROTECTION CLASS:- IP 65

MAXIMUM OPERATING TEMPERATURE:- 70°C

MOUNTING:- 1" NPT

ACCESSORIES:-

Din rail mounting power supply module.

- Input - 110-120/220-240V AC ±10%.
- Output - 20V DC
- LED Indications of DC power on and flame on

DESCRIPTION.

The IRIS Uniscan flame monitor has been developed to satisfy the process heater and smaller utilities market, where the sophisticated discrimination techniques are not required.

The Uniscan however, offers certain adjustments, for discrimination purposes and flame drop out time.

The unique feature of the system is that all the electronics are situated in the viewing head - thus saving valuable panel space and expensive special cabling.

As the power regulation within the system is capable of a wide operating voltage range, 18V to 27V; losses due to long cable runs to the boiler front have little effect on the performance of the system.

The flame on signal is 20V DC (nominal) at a high milliampere level - and is therefore unaffected by site electrical noise and transients.

The electronics are housed in a cast aluminium EExd IIC T6 case giving protection to IP65 (Fig. 4).

The unit should be mounted as near parallel to the axis of the burner as is practical, looking into the primary combustion zone of the flame.

IRIS UNISCAN EExd - INSTALLATION & COMMISSIONING INSTRUCTIONS

INSTALLATION

The sighting position should be such that the viewing head is looking into the root of the flame - as near parallel to the axis of the burner as possible. Cooling air at a minimum rate of 1 CFM (1.7m³/h) should be provided by tee-ing into the sight tube.

The pipe connection for the EExd housing is 1" NPT.

WIRING

There is a 6 way terminal block (Fig. 2) which must be removed to facilitate wiring. This is done by gently levering the terminal block between its base and the printed circuit board. Wire should be BS5308 Part 2 type2, see Fig. 3 for wiring and cable details.

Providing the wire is sized correctly, there is no upper limit to transmission distance. The nominal supply voltage to the head is 20V DC.

This can vary between 16V and 27V without detriment to the performance.

IMPORTANT

The EExd housing must be earthed according to local regulations.

SETTINGS

Flame drop out: -

1, 2 or 3 seconds - factory supplied at 2 seconds

Discrimination Selector:-

1, 2, 3 or 4 positions – factory supplied at 1

Flame sensitivity:

25 turns - clockwise to increase - factory set at 12.

Should be set to flame on signal strength on meter between 15 - 20mA.

To vary these settings it is necessary to remove the card from the EExd housing. This is achieved by removing the screwed end cover, unplugging the 6 way terminal block, removing the earth cable connected to the board by releasing the screw from the housing and releasing the two screws either side. The card can then be pulled out as far as the detector flying lead will permit.

The 6 way terminal block can be replaced to allow live commissioning - however, we recommend that the card removal is done with the unit de-powered.

To remove the card completely, just unplug the detector plug (Fig. 1) - but please note that it is a polarised plug and socket.

SETTING UP PROCEDURE.

1. With the subject flame off, turn the 25 turn potentiometer (Fig. 1) clockwise to increase the gain, but not so far that the unit indicates flame on. Place the discrimination switch in POS.1 (Fig. 1).

2. Ignite the burner and bring up to normal firing. Adjust the gain so that the meter reading is approx. 15mA.

3. Extinguish the flame and note the meter reading. If it is greater than 3mA with flame off, place the discrimination switch into POS.2.

4. Repeat paragraph's 2 & 3, placing the discrimination switch into positions 3 & 4 if necessary until the best differential between flame on and flame off is achieved.

5. On difficult applications it may be necessary to re-sight the viewing head slightly so that the flame on reading is slightly lower, but a greater differential between flame on and flame off is achieved.

SIGHTING (See Figure 5)

The first 30% of the flame, the root, radiates the most intense ultraviolet and high frequency infra-red emissions. Sighting along the flame rather than across it permits the Uniscan to view a greater depth of the flame root, obtain a higher signal and help eliminate nuisance trips due to flame movement or adjacent flame activity.

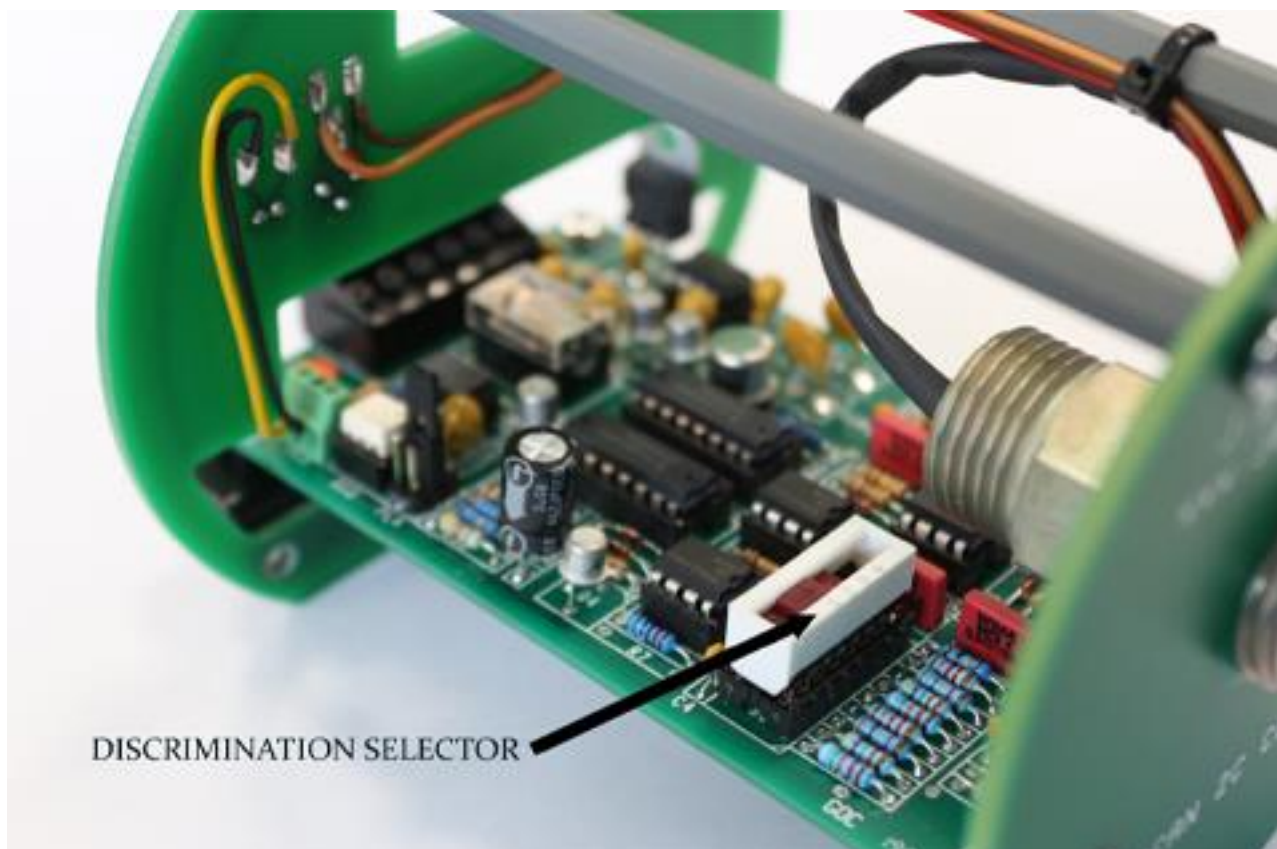

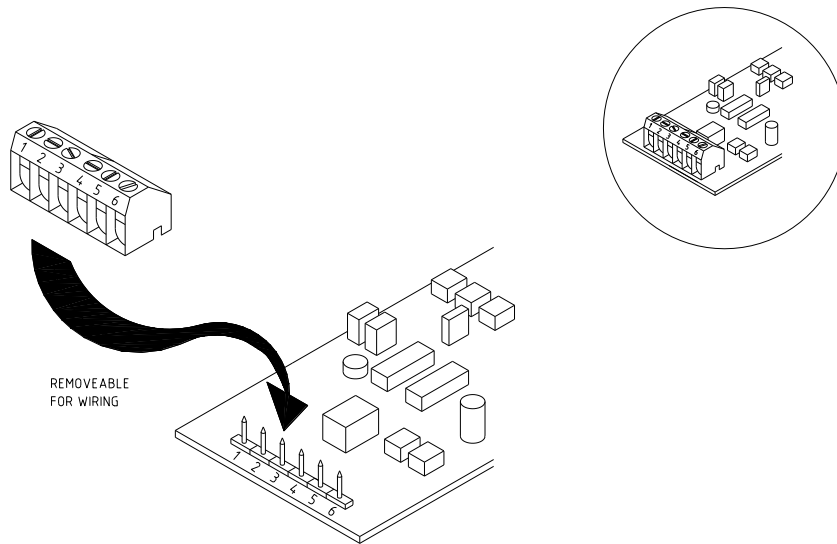

FIG. 2 IRIS UNISCAN - WIRING CONNECTOR

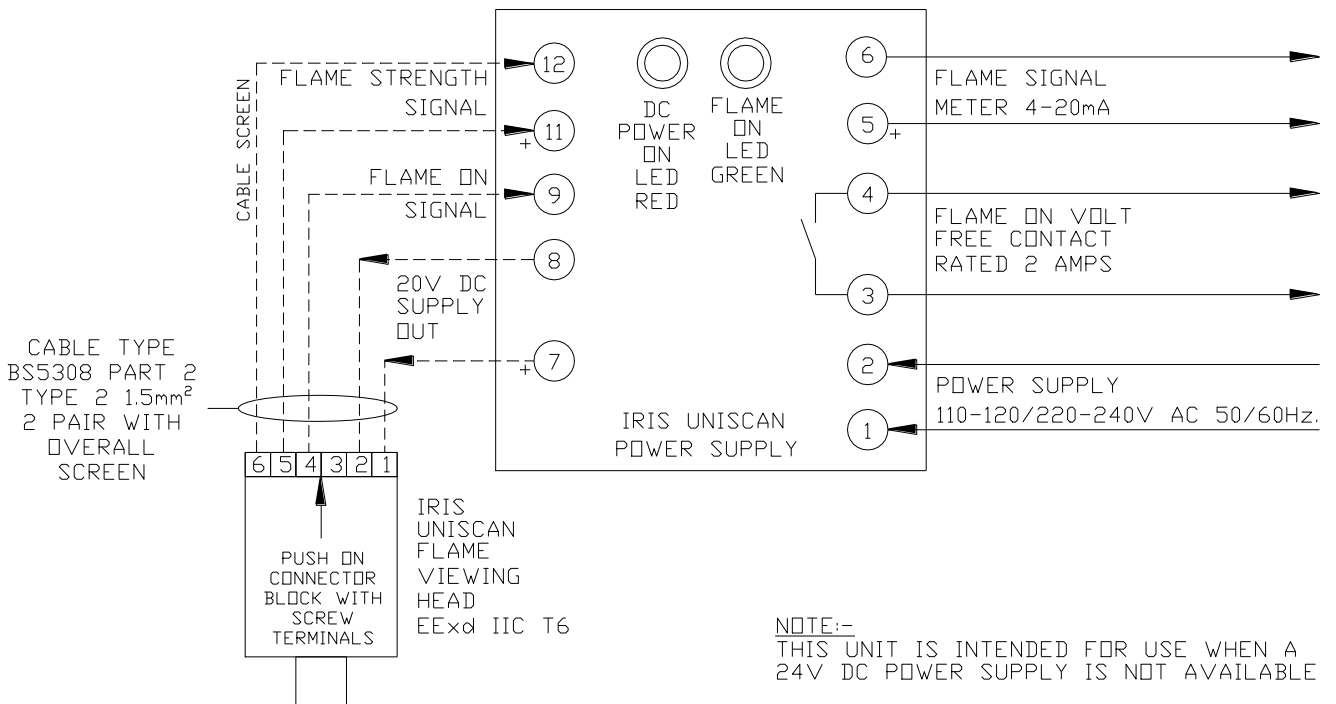
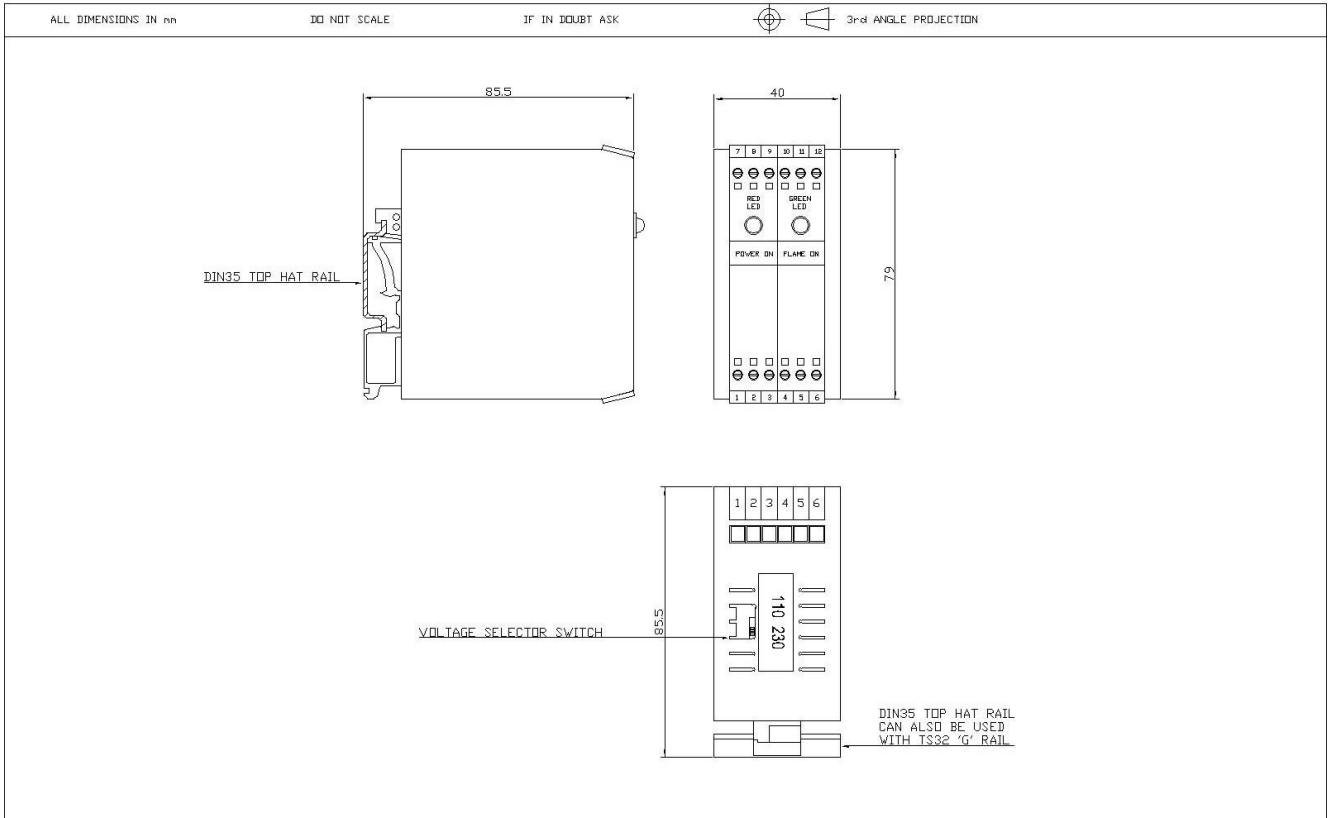

FIG. 3 UNISCAN POWER SUPPLY AND WIRING



J.B. SYSTEMS LTD.		The Bridgegate Business Park Cathouse Way, Aylesbury Bucks. HP19 8XN E-mail: info@jbsystems.co.uk Web Site: www.jbsystems.co.uk				TITL		QTY		SCALE	
TEL: (01295) 489957 FAX: (01295) 393515						GENERAL ARRANGEMENT OF UNISCAN POWER SUPPLY		-		NTS	
IRIS FLAME MONITORING		Weldmaster HAZARDOUS		A.T.X. ROSE		TESTI IGNITION EQUIPMENT		DB		DATE	
				0		FIRST ISSUE		JAN 2005		-	
				ISSUE		CHANGES		BY		DATE	
								AGREEMENT:		CHECKED BY:	
								-		-	
								DATE:		JAN 2005	

FIG. 3 UNISCAN POWER SUPPLY AND WIRING

TERMINATIONS:

- 1 - 24V DC SUPPLY IN
- 2 - 0V DC SUPPLY IN
- 3 - NO CONNECTION
- 4 - FLAME ON 24V DC
- 5 - 4-20mA ANALOGUE +
- 6 - 4-20mA ANALOGUE -

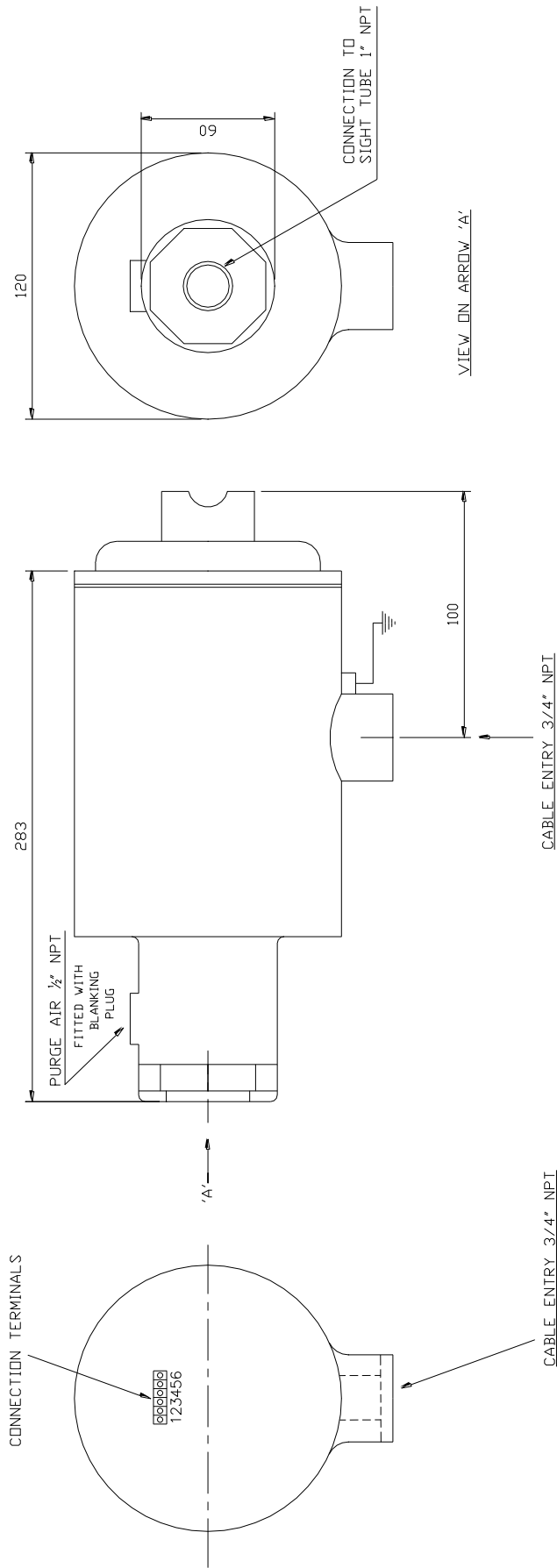

NOTES:

ALL DIMENSIONS IN MILLIMETRES
 WEIGHT : 3.0 kgs.
 CERTIFICATION : EExd II C T6 CESI/GENELEC

FIG. 4 IRIS UNISCAN - EExd SCANNER HEAD

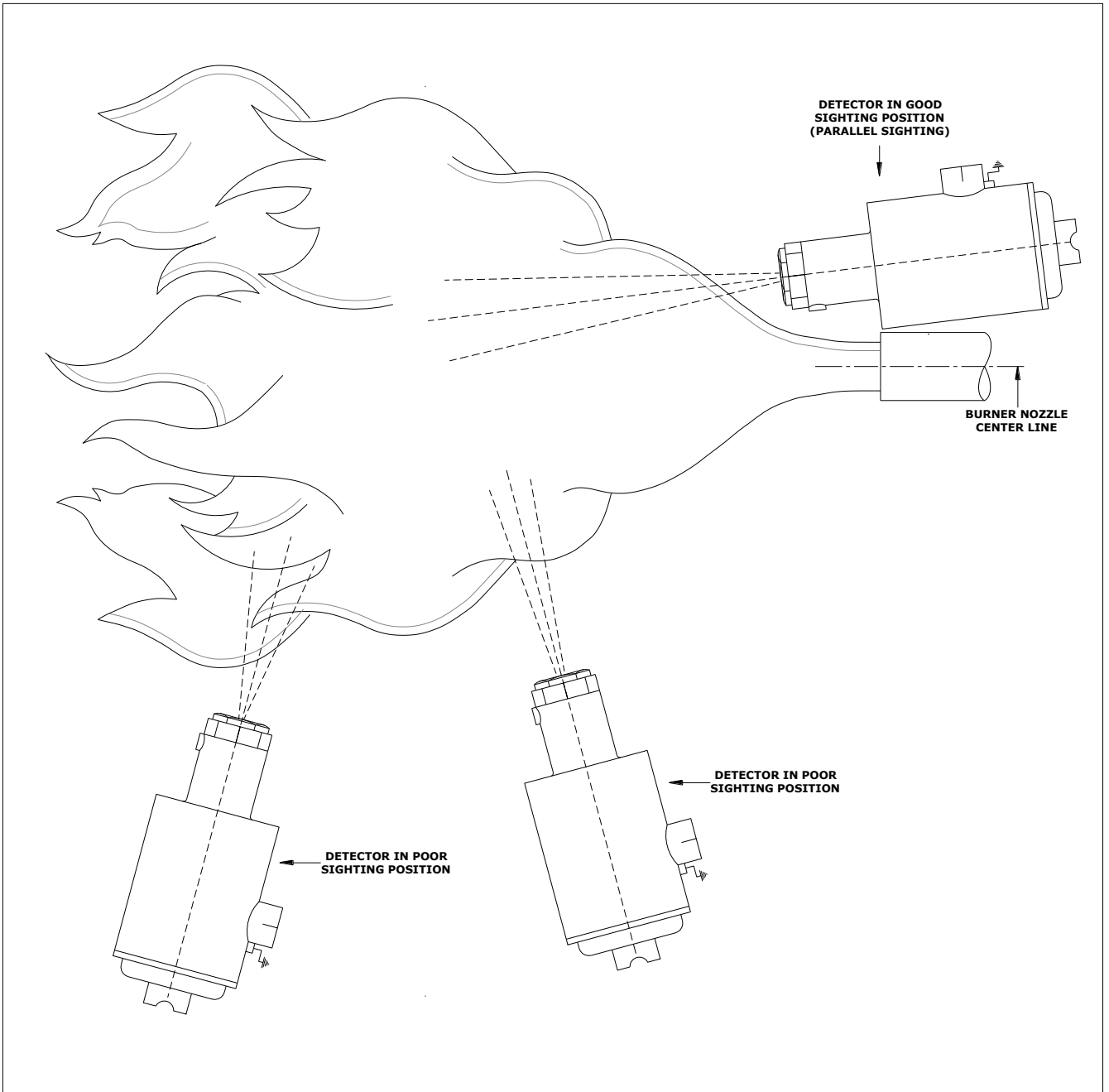

FIG 5: UNISCAN HEAD SIGHTING